



# FU XIANG CABINETS WAREHOUSE

KITCHEN • BATH • ORGANIZATION

## ASSEMBLY INSTRUCTIONS

### Lazy Susan Base Cabinets

(This assembly instruction sheet applies for Lazy Susan Base Cabinets.)

❖ **General Instruction**

- Read the instruction carefully before starting the installation.
- Follow all generally accepted safety procedures during assembly.

❖ **Parts List:** The following items are included in the carton.

#### LAZY SUSAN BASE CABINET for AWK, MM, COG, BCR, and BCF

ITEM	DESCRIPTION	Qty
A	Face Frame/Door	2 (Small & Big)
B	Side Panel	2 (Left & Right)
C	Back panel	2 (Left & Right)
D	Bottom Panel	1
E	Shelf	1
F	Turntable	2
G	Turner	2
H	Long Toe Kick	1
I	Short Toe Kick	1

#### LAZY SUSAN BASE CABINET for MC, BE, BN and LD

ITEM	DESCRIPTION	Qty
A	Face Frame/Door	2 (Small & Big)
B	Side Panel	2 (Left & Right)
C	Left & Right Back Panel	2
D	Back Panel	1
E	Bottom Panel	1
F	Shelf	1
G	Turntable	2
H	Turner	2
I	Long Toe Kick	1
J	Short Toe Kick	1

**NOTE: FACE FRAME & DOOR** for BCF and BCR are in separate carton



## FU XIANG CABINETS WAREHOUSE

KITCHEN • BATH • ORGANIZATION

❖ **Instruction** : AWK, MM, COG, BCR, and BCF LAZY SUSAN

- **STEP 1:** Assemble Bottom and Shelf turntable set: put bottom panel (D) on a soft surface. Make sure the side has screw marks face up. Put the Turner (G) on top of it. Align them with screw marks and secure with ½" large head screws. Then, put Turntable (F) on a soft surface. Make sure the side has screw marks face up. Put bottom panel (D) on the top of it with assembled turner face down. Use the hole on the bottom panel (D) to find the screw marks and secure with ½" large head screws. Now the Bottom w/ Turntable set is ready. Use the same procedure for building the Shelf (E) w/Turntable set.
- **STEP 2:** Assemble left side panel (B) attach to the left back panel (C).
- **STEP 3:** Assemble right side panel (B) attach to the right back panel (C).
- **STEP 4:** Assemble big face frame (A) attach to the left side panel (B) & the right back panel (C). Insert bottom panel w/ turntable on the face frame.
- **STEP 5:** Assemble Door set: Install door on small frame (A), then attach small frame w/ door between the big frame (A) & right side panel (B).
- **STEP 6:** Insert shelf w/ turntable into position on short shelf steps.
- **STEP 7:** Screwing short toe kick (I) to long to kick (H) with metal hardware, then put onto the cabinet under the door. Make sure that all fits. Reposition the cabinet back to upright and connect bottom to the frame under the door.

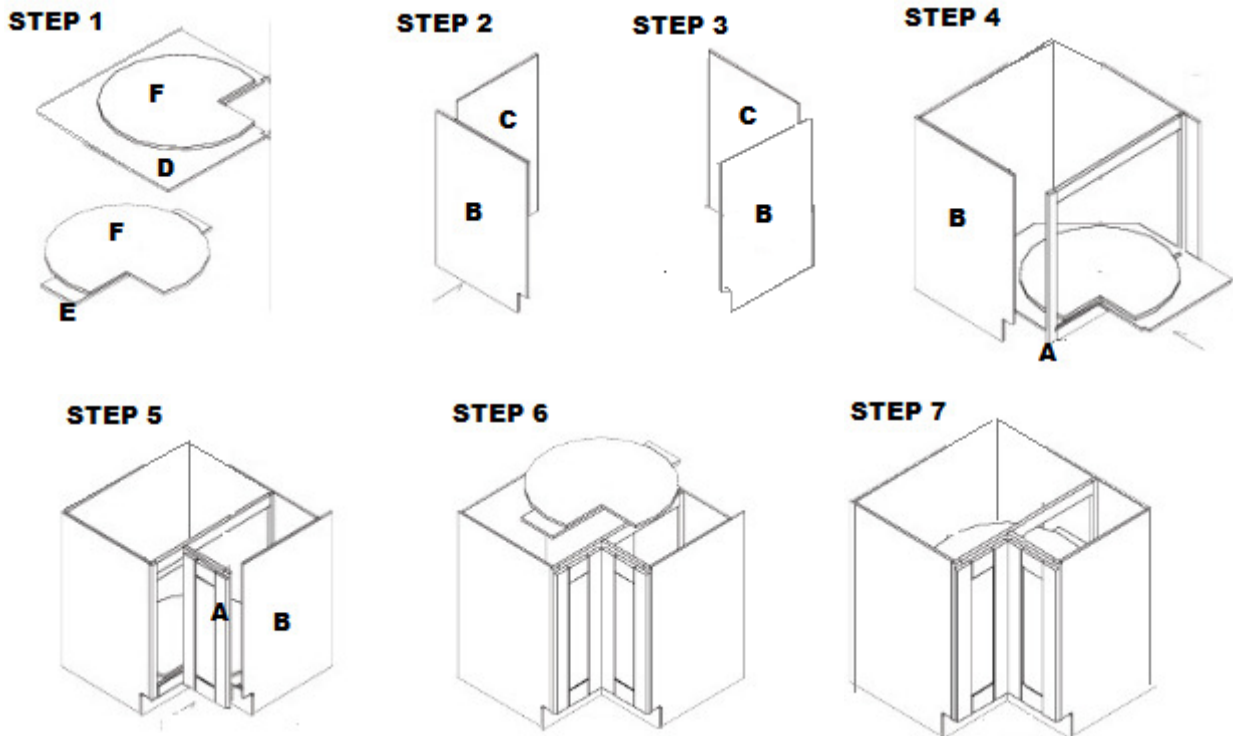



## FU XIANG CABINETS WAREHOUSE

KITCHEN • BATH • ORGANIZATION

### ❖ **Instruction** : MC, BE, BN and LD LAZY SUSAN

- **STEP 1:** Assemble Bottom and Shelf turntable set: put bottom panel (E) on a soft surface. Make sure the side has screw marks face up. Put the Turner (H) on top of it. Align them with screw marks and secure with ½" large head screws. Then, put Turntable (G) on a soft surface. Make sure the side has screw marks face up. Put bottom panel (E) on the top of it with assembled turner face down. Use the hole on the bottom panel to find the screw marks and secure with ½" large head screws. Now the Bottom w/ Turntable set is ready. Use the same procedure for building the Shelf (F) w/Turntable set.
- **STEP 2:** Assemble left side panel (B) attach to the left back panel (C).
- **STEP 3:** Assemble right side panel (B) attach to the right back panel (C).
- **STEP 4:** Assemble big face frame (A) attach to the left side panel (B) and the right back panel (C). Insert bottom panel w/ turntable (E) on the face frame.
- **STEP 5:** Assemble Door set: Install door on small frame (A), then attach small frame w/ door between the big frame (A) & right side panel (B).
- **STEP 6:** Insert shelf w/ turntable into position on short shelf steps.
- **STEP 7:** Place the back panel between left & right back panels (C) and connect with metal hardware. Make sure that it fits and locked.
- **STEP 8:** Screwing short toe kick (J) to long to kick (I) with metal hardware, then put onto the cabinet under the door. Make sure that all fits. Reposition the cabinet back to upright and connect bottom to the frame under the door.

**STEP 1**

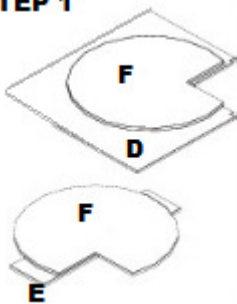

**STEP 2**

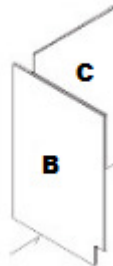

**STEP 3**

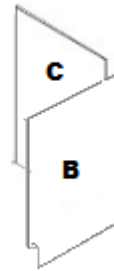

**STEP 4**

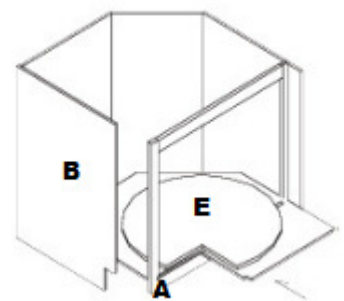

**STEP 5**

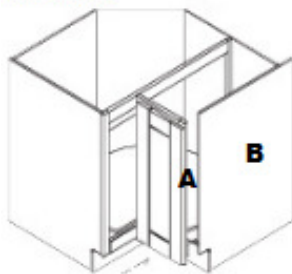

**STEP 6**

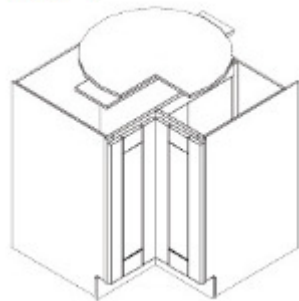

**STEP 7**

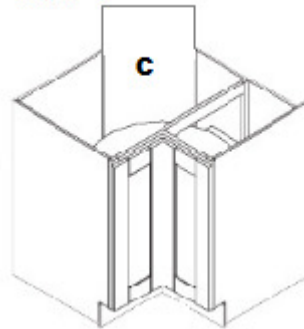

**STEP 8**

